

### Schottky Barrier Diode

#### FEATURES

- Low Forward Voltage Drop
- Guard Ring Construction for Transient Protection
- Negligible Reverse Recovery Time
- Low Capacitance

#### PINNING

PIN	DESCRIPTION
1	Cathode
2	Anode

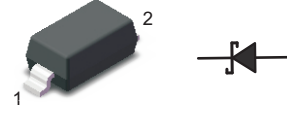

Top View

Simplified outline SOD-123 and symbol

#### MECHANICAL DATA

- Case: SOD-123
- Terminals: Solderable per MIL-STD-750, Method 2026
- Approx. Weight:16mg/0.00056oz

#### Maximum Ratings and Electrical characteristics

Ratings at 25 °C ambient temperature unless otherwise specified.

Parameter	Symbols	1N5819W S4	Units
Peak Repetitive Reverse Voltage	$V_{RRM}$	40	V
RMS reverse voltage	$V_{RMS}$	28	V
Working Peak Reverse Voltage	$V_{DC}$	40	V
Peak Forward Surge Current, 8.3ms single half sine-wave superimposed on rated load (JEDEC method)	$I_{FSM}$	13	A
Maximum Instantaneous Forward Voltage	$V_F$	$I_F=20mA$	0.37
		$I_F=200mA$	0.60
Power Dissipation	$P_D$	400	mW
Reverse current	$I_R$	$V_R=30V$	5
Thermal Resistance, Junction to Ambient Air	$R_{\theta JA}$	300	°C/W
Reverse voltage	$V_{(BR)}$	$I_R=100\mu A$	40
Reverse recovery time	$t_{rr}$	$I_F=I_R=200mA, I_{rr}=0.1 \times I_R, R_L=100\Omega$	10
Forward Continuons Current	$I_{FM}$	350	mA
Total capacitance	$C_{tot}$	$V_R=0V, f=1MHz$	28
Junction temperature	$T_j$	125	°C
Storage temperature	$T_{stg}$	-55 ~ +150	°C

**Fig.1 Power Derating Curve**

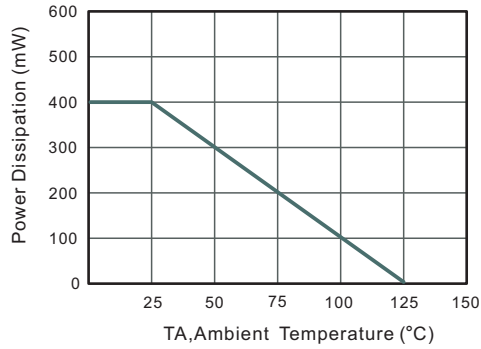

**Fig.2 Typical Reverse Characteristics**

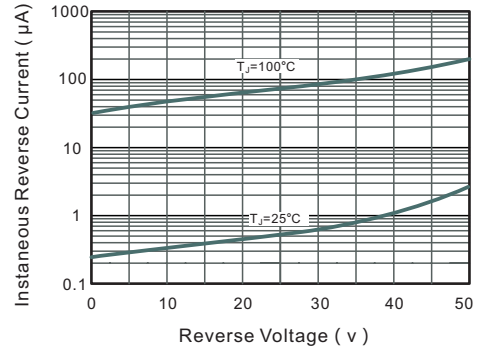

**Fig.3 Forward Characteristics**

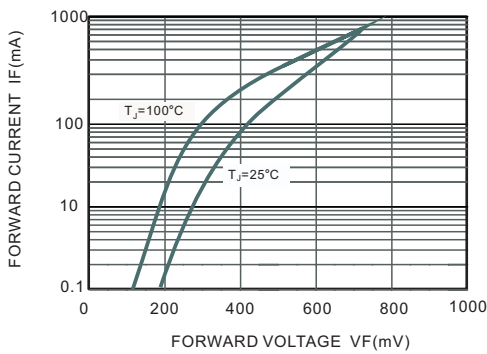

**Fig.4 Maximum Non-Repetitive Peak Forward Surge Current**

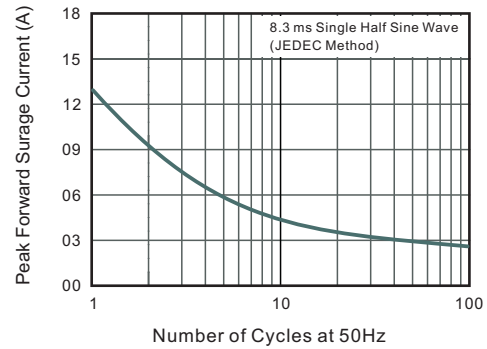

**Fig.5 Typical Junction Capacitance**

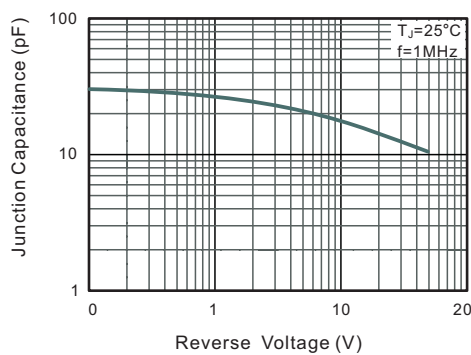

**Fig.6 Typical Transient Thermal Impedance**

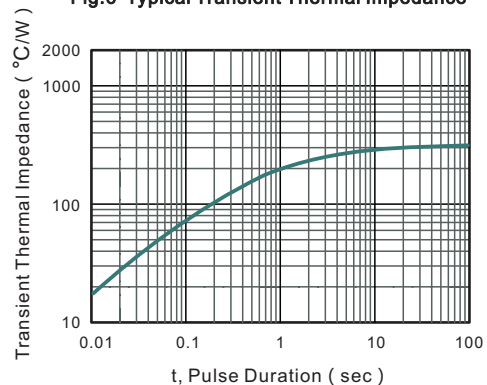

**PACKAGE OUTLINE**

Plastic surface mounted package; 2 leads

**SOD-123**

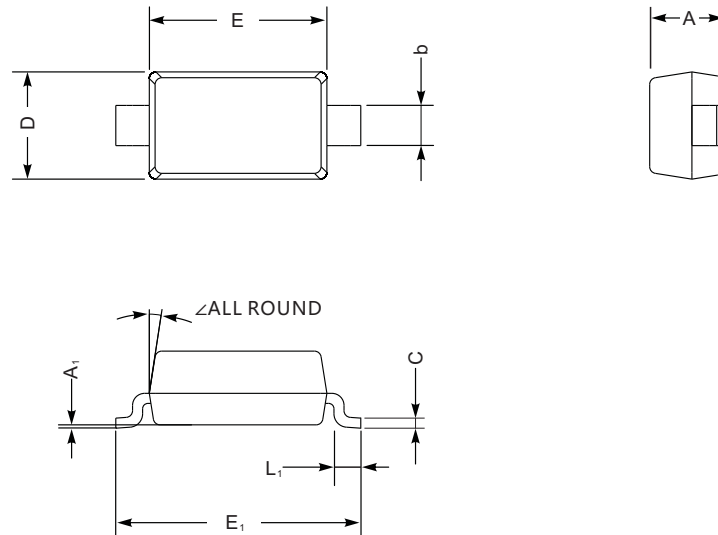

SOD-123 mechanical data

UNIT		A	C	D	E	E <sub>1</sub>	L <sub>1</sub>	b	A <sub>1</sub>	∠
mm	max	1.3	0.22	1.8	2.8	3.9	0.45	0.7	0.2	9°
	min	0.9	0.09	1.5	2.5	3.6	0.25	0.5	—	
mil	max	51	8.7	71	110	154	18	28	8	
	min	35	3.5	59	98	142	10	20	—	

**The recommended mounting pad size**

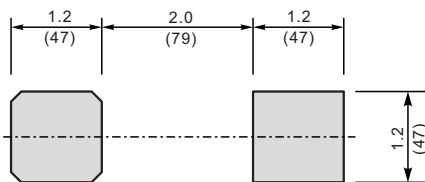

Unit:  $\frac{\text{mm}}{\text{mil}}$